



Quick-Garden



FILL

Assembly instructions



<u>PRODUCT NAME</u>	<u>FILL</u>
<u>REFERENCE NUMBER</u>	

No.	Size, mm			Detail stock	Details	Annotation
	Length	Width	Thick			
1	5670	65	43	1		Wall B
2	5670	130	43	3		Wall B
3	5620	130	43	4		Wall B
4	4910	65	43	1		Wall B
5	4910	130	43	3		Wall B
6	4960	130	43	4		Wall B
7	3990	65	43	3		Wall A D
8	3990	130	43	29		Wall A D
9	1300	130	43	48		Wall A B
10	2220	130	43	16		Wall B
11	400	130	43	2		Wall E C
12	1048	130	43	52		Wall E C
13	2956	65	43	2		Wall E C
14	331	130	43	8		Wall C
15	207	130	43	8		Wall C
16	5950	130	43	1		Wall I
17	5950	130	43	6		Wall I
18	5950	130	43	1		Wall I
19	1766	130	43	16		Wall I
20	998	130	43	8		Wall I
21	5950	130	43	16		Wall J
22	5950	130	43	7		Wall H
23	5950	130	43	1		Wall H
24	5950	130	43	1		Wall H
25	1611	130	43	15		Wall H
26	1936	130	43	15		Wall H
27	683	130	43	15		Wall H
28	5950	130	43	7		Wall G
29	5950	130	43	1		Wall G
30	5950	130	43	1		Wall G
31	3349	130	43	15		Wall G
32	1741	130	43	15		Wall G
33	6743			1		Roof frame triangle
34	10530			1		Roof frame triangle
35	10530			1		Roof frame triangle
36	3990			1		Roof frame triangle
37	5950	130	60	1		Rafters
38	5950	130	60	4		Rafters
39	5950	130	60	2		Rafters
40	2900					Roof boards
41	2600			66 m ²		
42	3735			43,4 m ²		
43	2700			12,42 m ²		
44	2700			3,2 m ²		Terrace floor board
45	5600	105	20	4		Wind boards
46	5625	105	20	4		Wind boards
47	5625	60	16	4		Wind boards borders
48	5950	105	20	2		Roof plank
49	5950	35	25	2		Roof plank borders
50	5950	60	18	2		Ceiling borders
51	3744	35	25	6		Floor trim
52	2710	35	25	4		Floor trim
53	5704	35	25	2		Floor trim
54	3043	35	25	2		Floor trim
55	1075	35	25	4		Floor trim
56	1600	35	25	2		Floor trim
57	1400	35	25	2		Floor trim
58	1500	35	25	4		Floor trim
59	5790	50	70	20		Bearers
60	300	140	20	2		Decorative diamond
61	2000	850	43	1		Door
62	2000	850	43	1		Door
63	2000	850	43	1		Door
64	2000	850	43	2		Door
65	1010	1380	43	4		Window
66	1010	700	43	3		Window
67	500	500	43	2		Window

Screws			Nails		
	3.5x5	For windows and doors		2.5x6	For boards
	3.5x3	For roof decorative parts			

IMPORTANT (Read carefully before starting)!

- The following instructions include both pictures (indicating every part by the digits – see part list above) and illustrations. Please keep in mind that the illustrations are just a general guide to assembling all our products (For example: The illustration on how to assemble a roof applies to all our roofs). However specific models will vary in the quantity of materials needed. By closely consulting the part-list, you will know how many parts you need for each stage of the assembly, while the illustrations will show you how put them together.

- If some extra boards are left over after assembling your product, do not worry. We sometimes include extra boards to ensure that the delivery package is perfectly compact and solid.

1. General instructions

Read carefully before starting. First of all, we want to thank you for buying one of our products. Please read these instructions carefully before unpacking the parts.

2. Storing your product prior to assembly.

Your unpacked product must be stored in a dry, ventilated place, where it is protected from the weather (the package is not waterproof) and direct sunlight. The package and parts should be laid flat on the ground in order to avoid any damage to them. We strongly recommend assembling the product as soon as possible after it is delivered, because any complaints regarding missing or damaged parts can only be made up to 10 days after the date of delivery.

3. Safety.

The wooden parts may cause splinters, so please handle them carefully and wear protective gloves. Make sure there are no protruding nails, screws or staples in the assembled pieces. Always follow the instructions carefully and keep to the order of steps.

4.Assembly.

Before starting to assemble your structure, we strongly recommend that you watch our video guide on our website www.quick-garden.co.uk (under the category "Assembly"). During the installation process constantly check that everything is level and parallel. For all parts that need to be assembled using screws, it is advisable to pre-drill holes to avoid the risk of splitting the wood during screwing.

4.1. Familiarize yourself with the parts. All parts are numbered, so start by checking that all parts are present by matching them off against your instruction manual. We recommend you sort the parts into separate piles. You will need a rubber hammer, electric screw-driver and anchor screws.

4.2. Foundation. Before starting the installation, make sure that the building surface is perfectly flat and level. Lay the foundation elements (PVC blocks, concrete slabs, etc.) For floorless models, the foundation should be at least the same size or larger (recommended) than the external dimension of the structure.

4.3. Bearers. The bearers must be placed according to the picture (general sample) below with gaps of around 50cm between each other. Screw the bearers into the foundation with anchor screws.

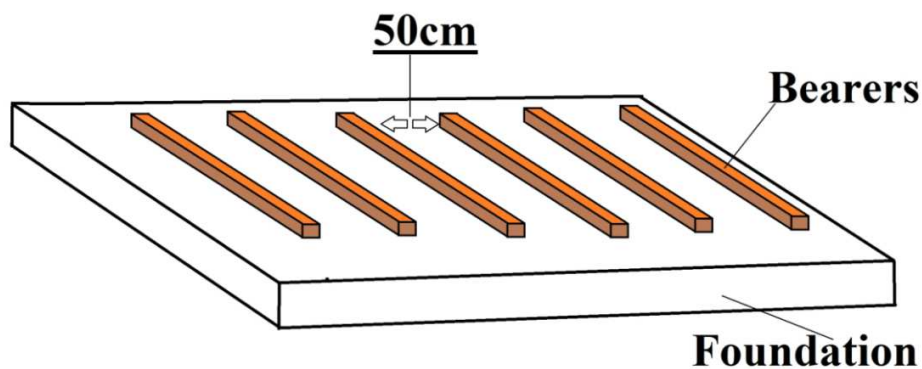

The actual plan:

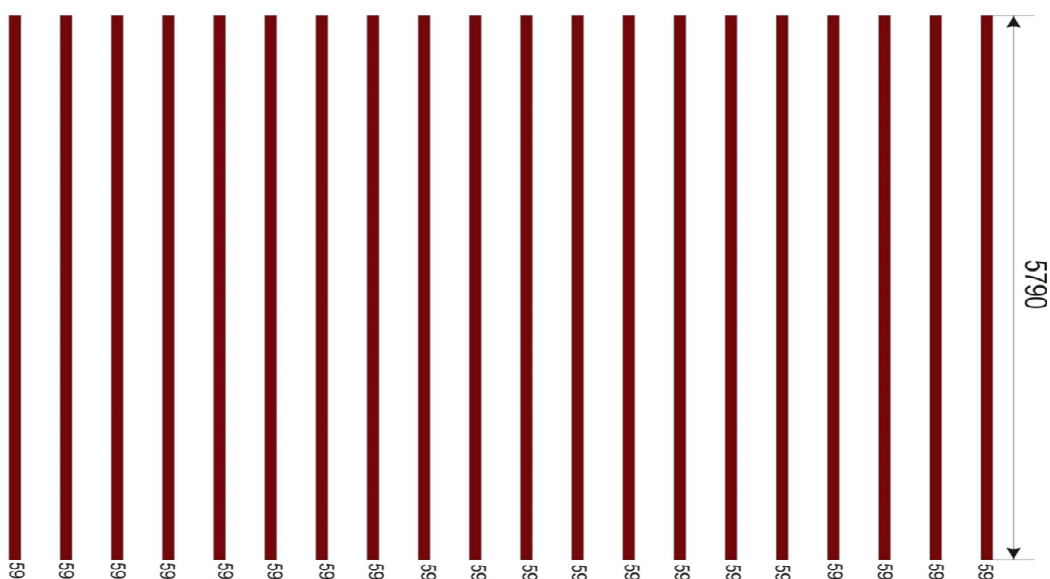

4.4. Assembling the walls: place the wall-boards on the bearers as shown below:

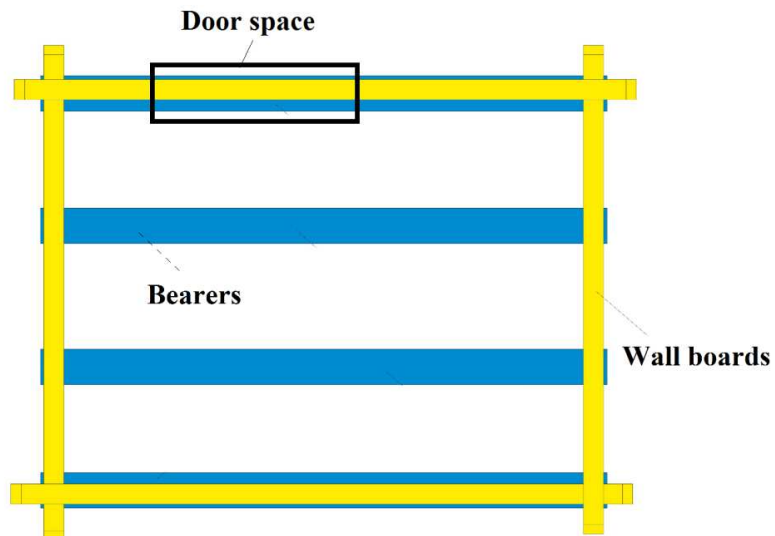

The wall-boards must be placed so that the ends interlock. Now screw the first row of wall-boards into the bearers. All the following rows of placed wall-boards should interlock not only at the ends, but along their length as well. Please screw each new row of wall-boards into the former row to ensure a solid structure.

The plan:

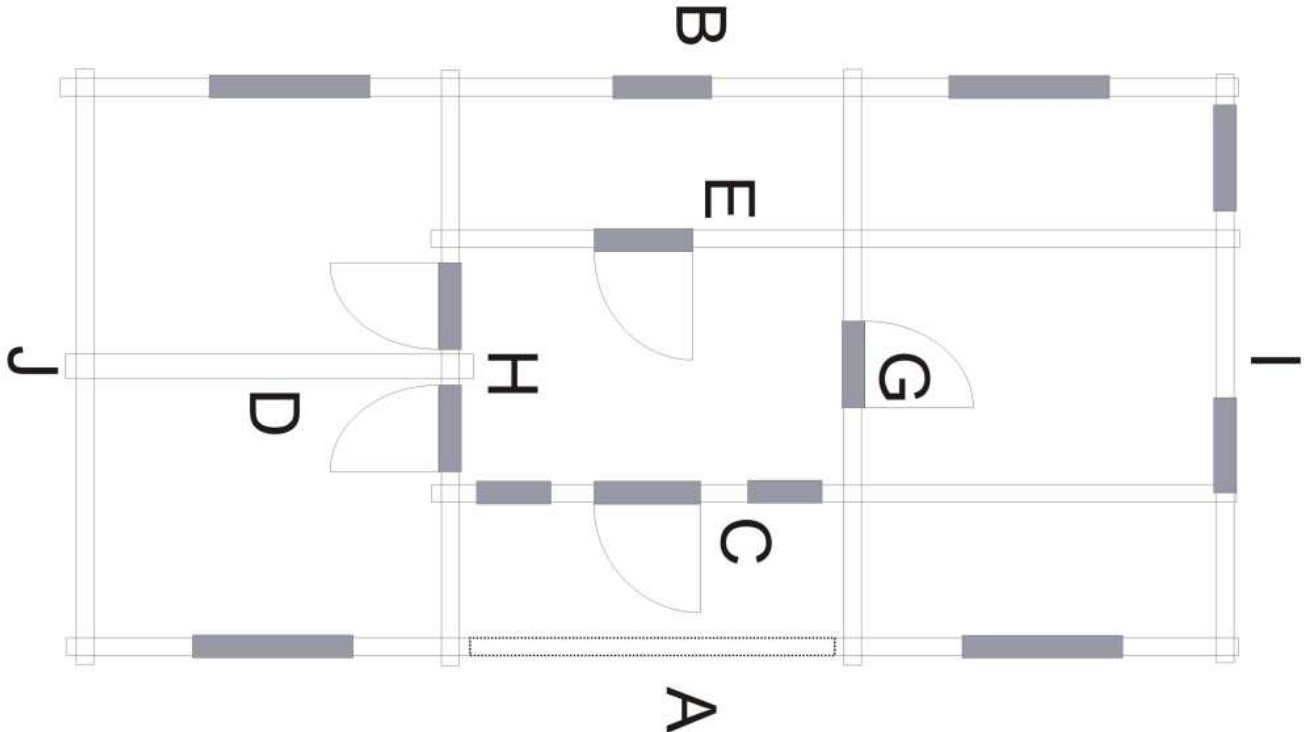

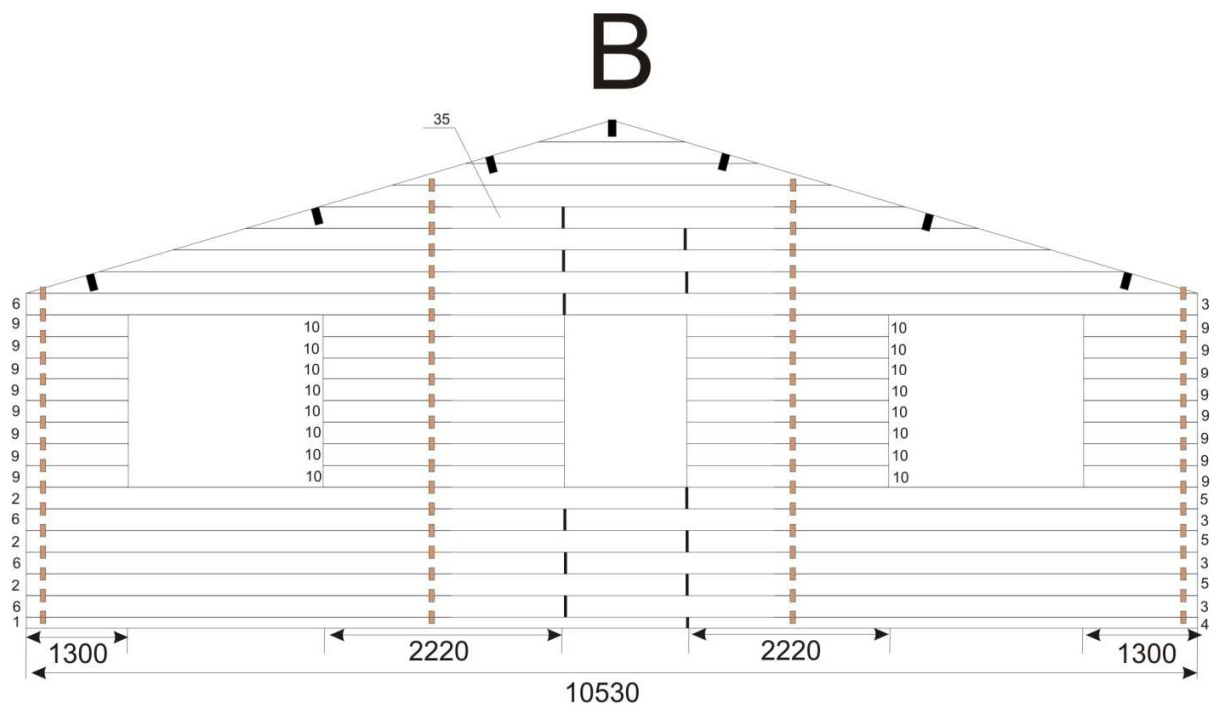
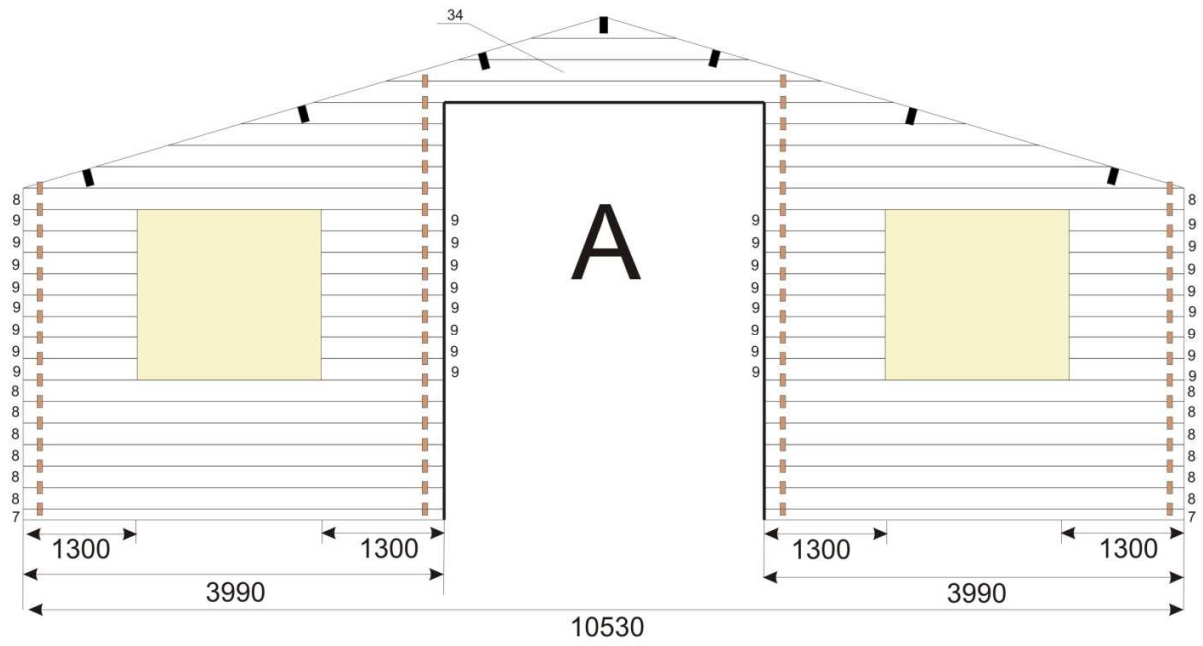

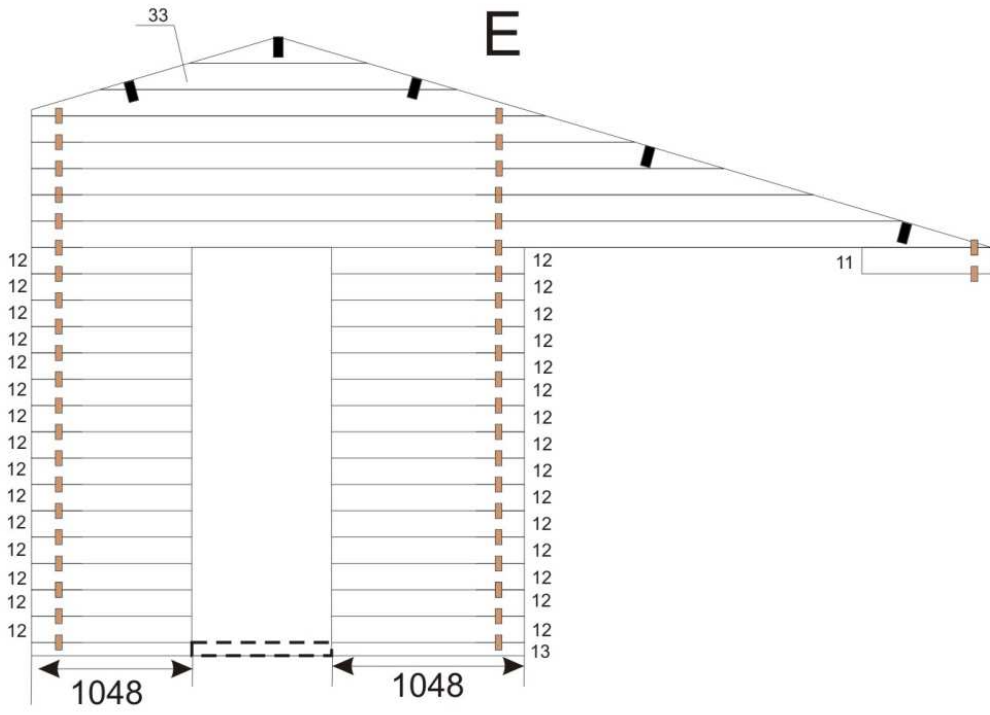
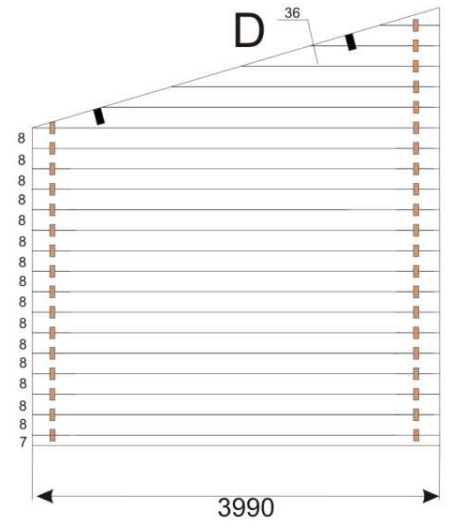
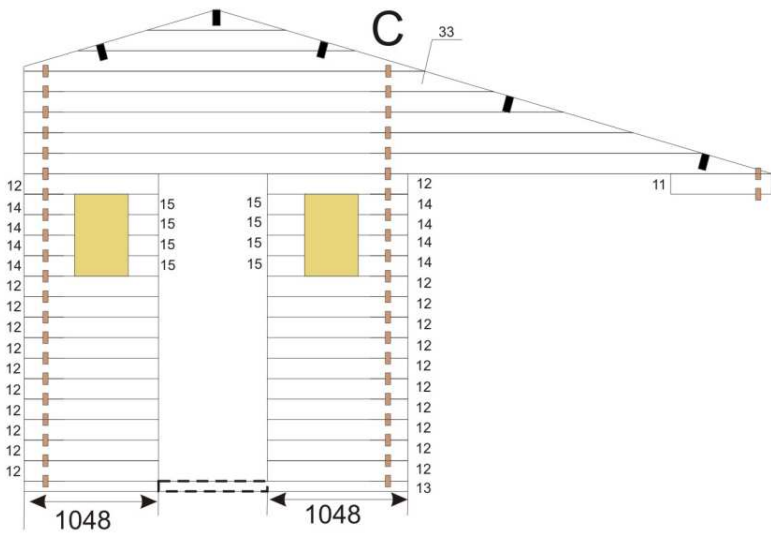

G

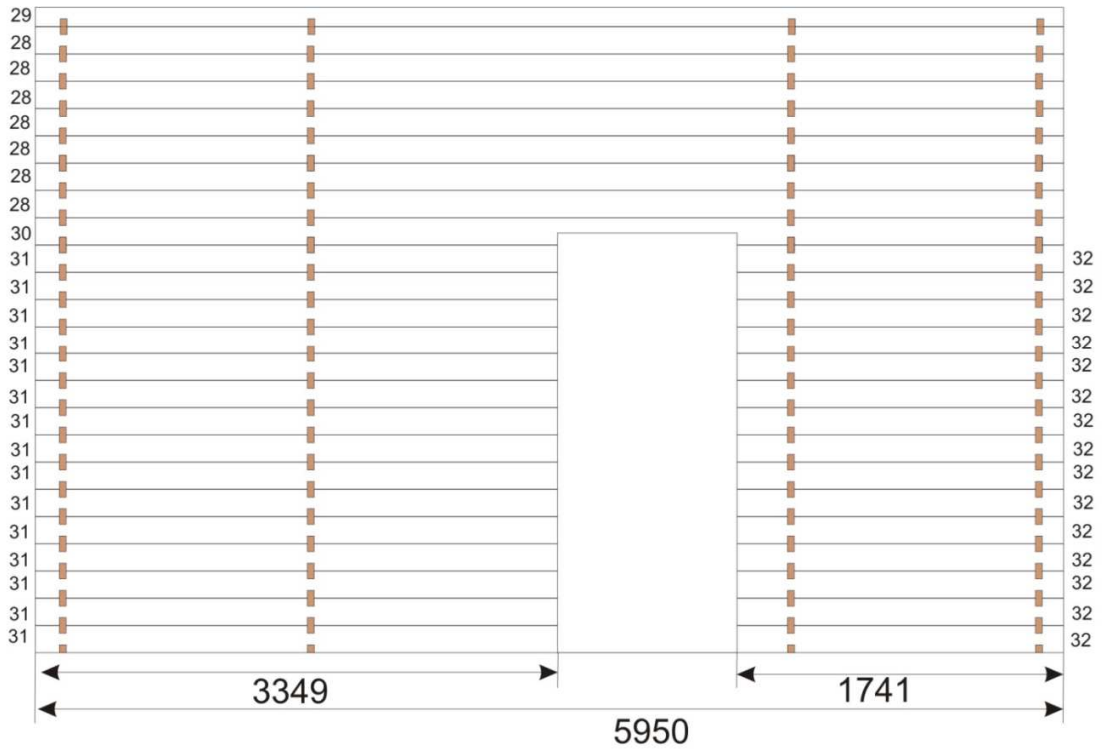

H

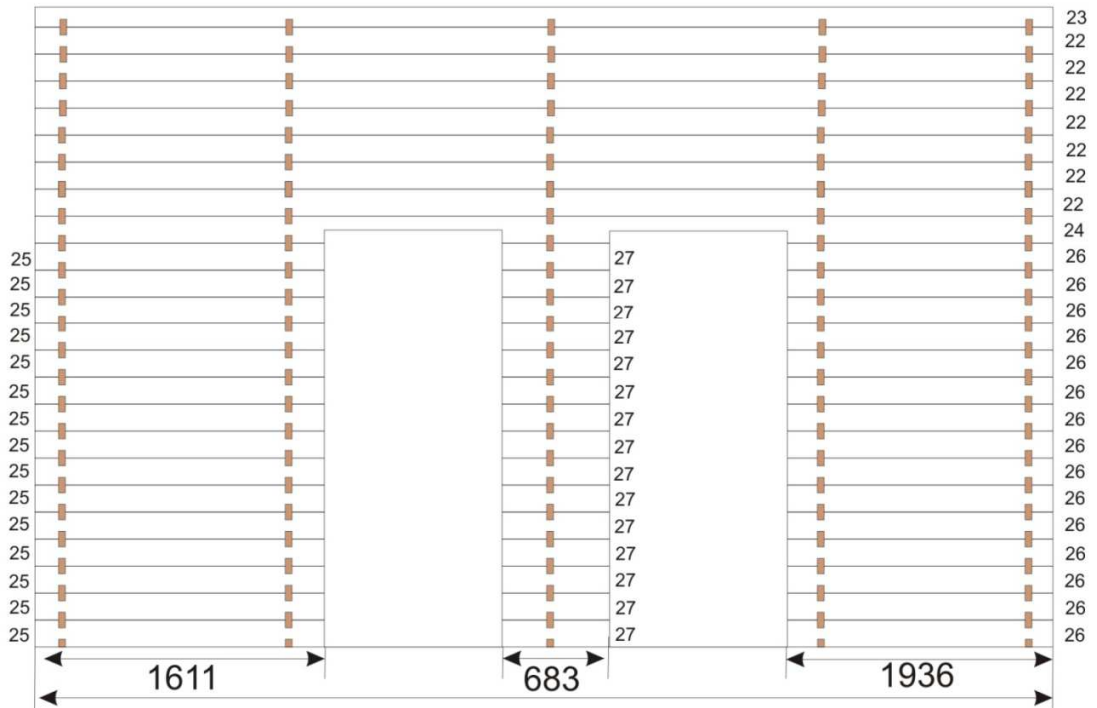

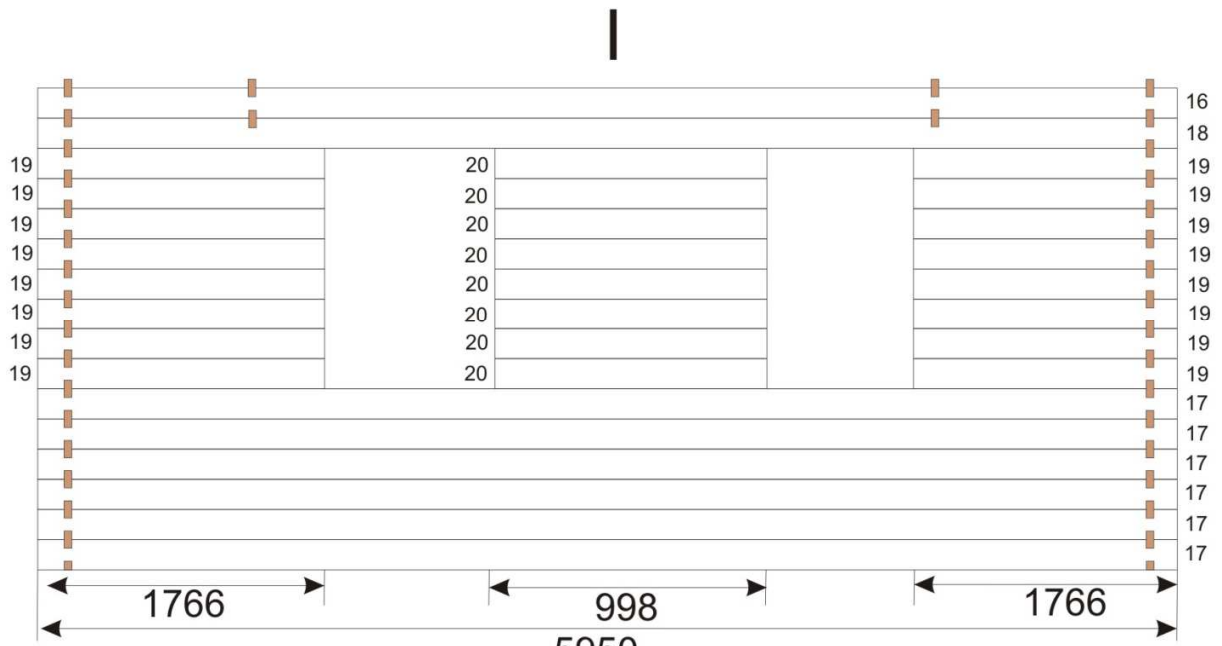

4.5. Roof frame triangles: After the walls are assembled, mount the roof frame triangles. These should be mounted as whole structures.

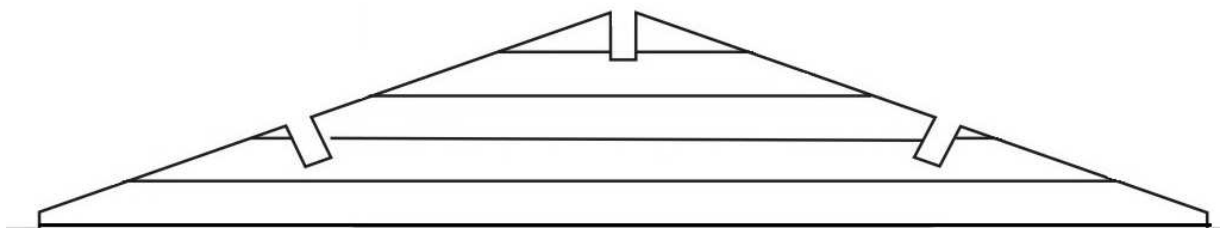

4.6. Rafters: The rafters must be mounted horizontally and inserted in the mounting-spaces found on the roof frame triangles. The rafters share a common mounting-space in the middle one of the three triangles. Here are two types of rafter-mounting shown below (picture)

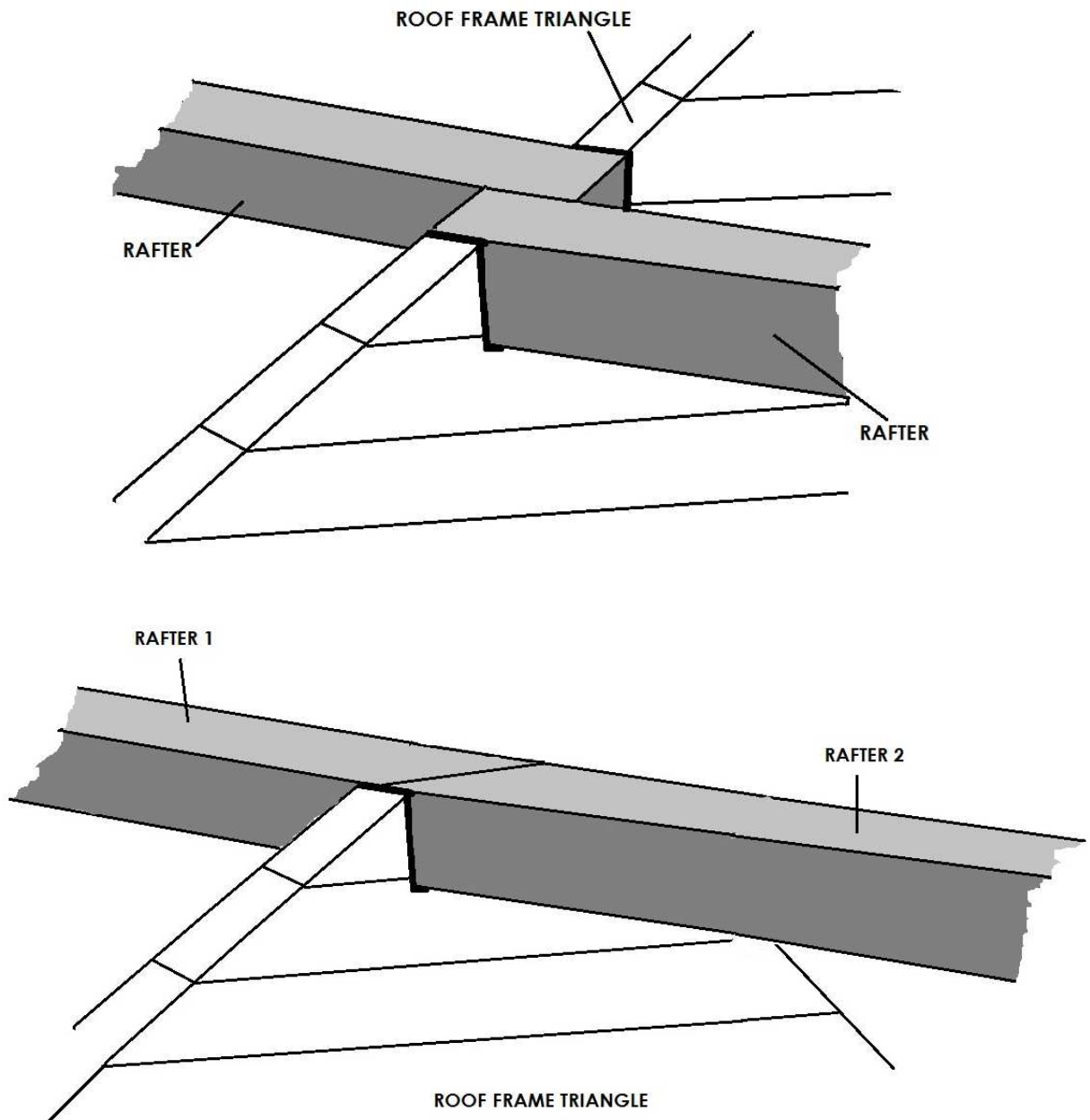

4.7. Roof-boards: The next step is to attach the roof-boards vertically and screw them into the rafters. Make sure the ends of the roof-boards are perfectly parallel to each other. Then fix the roof plank border under the roof-boards as show below. The roof-plank must be screwed to the roof plank border.

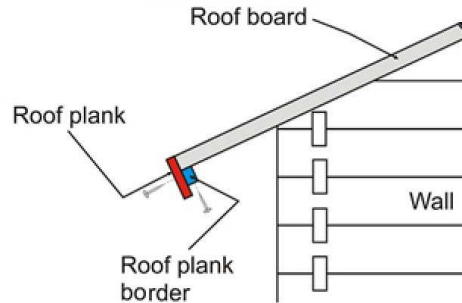

4.8. Wind-boards: Place the wind-boards on top of each other to make a 90 degree angle. Now attach these ones on a roof frame triangle and fix by screwing them in.

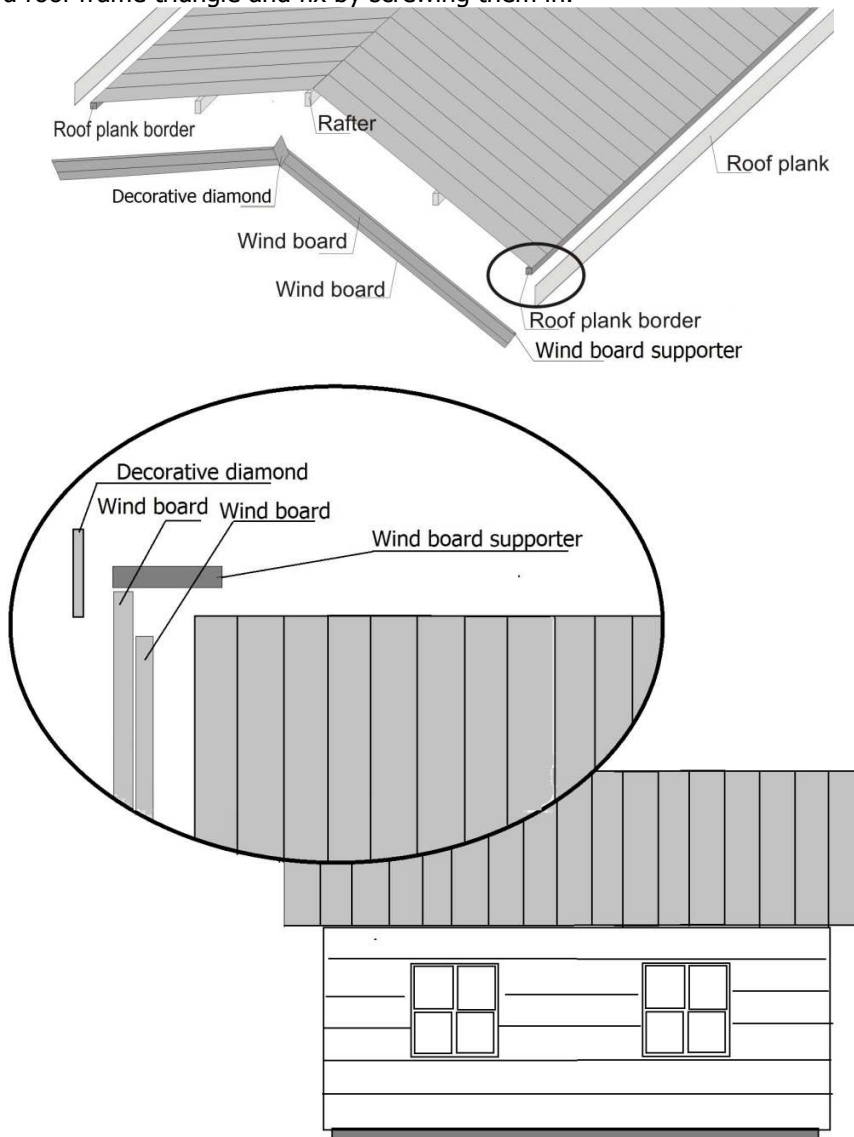

4.9. Door: Screw the support trims in to the door frame.

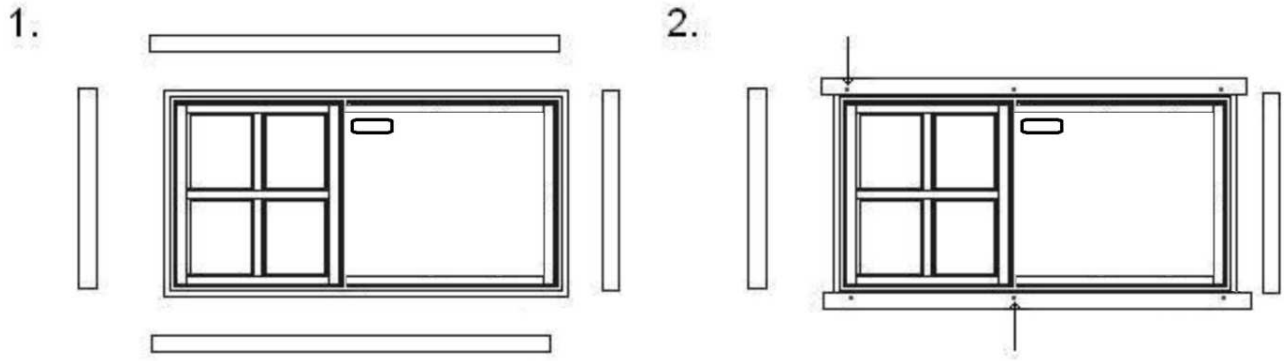

Insert door frame in to its space from the outside of the structure. Then fix the rest of the support trims from inside the building:

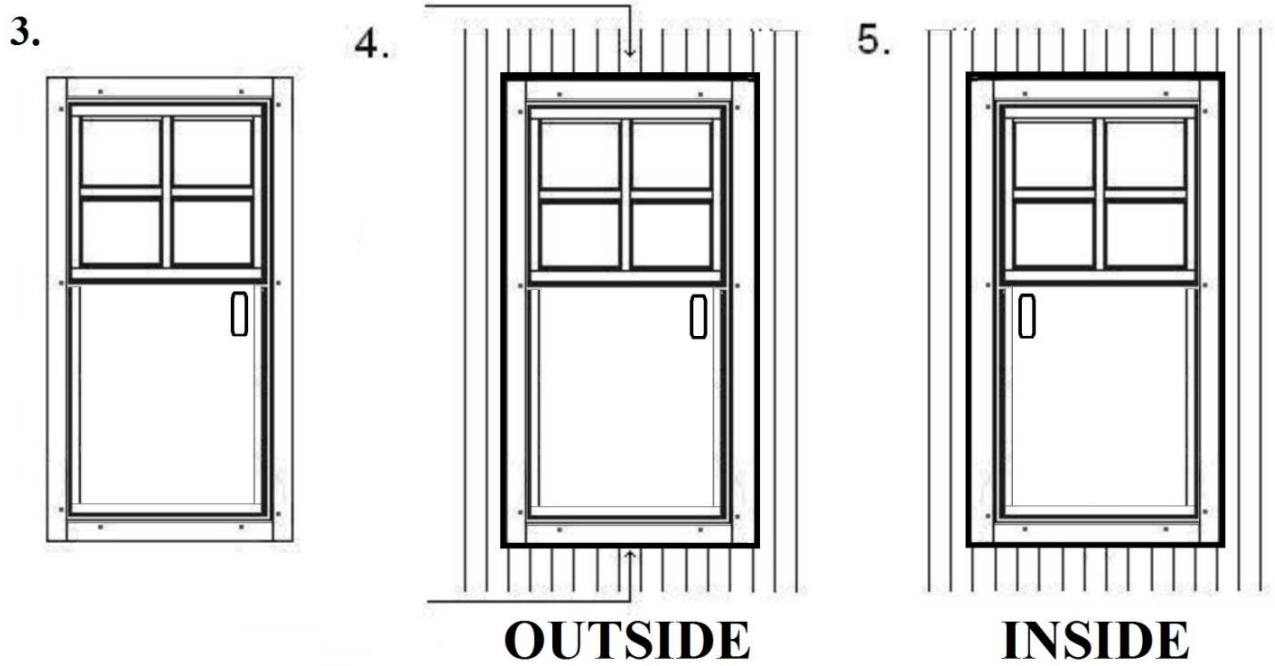

Notice:

- Keep in mind that the support trims must be screwed to the door frames, not to the wall-boards!
- Do not worry about the space between the wall and upper window frame. The wood will naturally contract so that the space should disappear within a month or so. Do not try to fill the space in yourself during the assembly process.

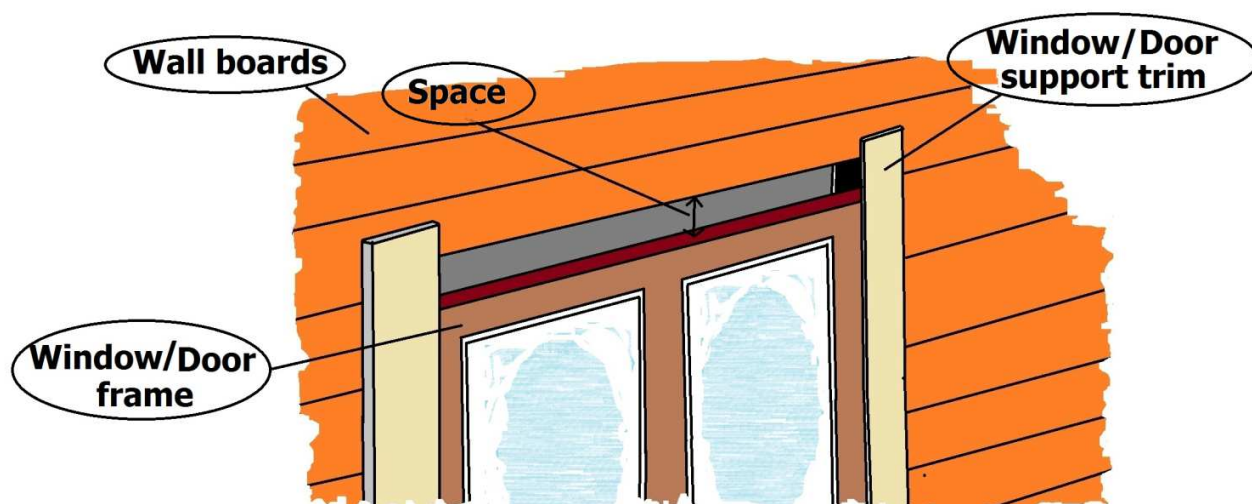

4.10. Windows: The windows must be installed in the same way as the door:

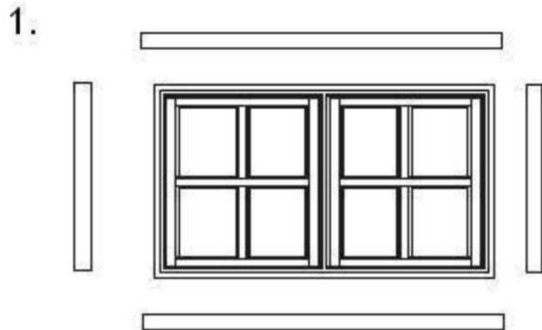

Place the window frame and four support trims on the stable surface.

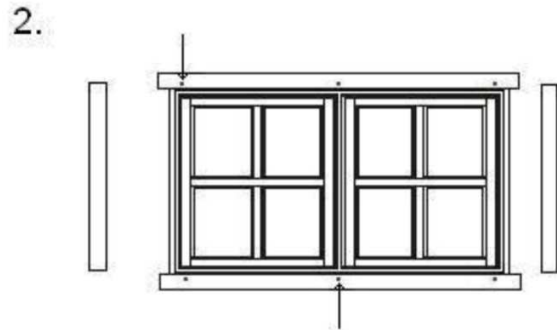

Drill the holes in the support trims and screw them in to the window frame.

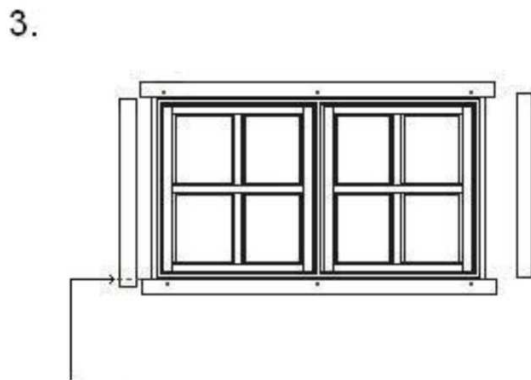

Cut the support trims if necessary

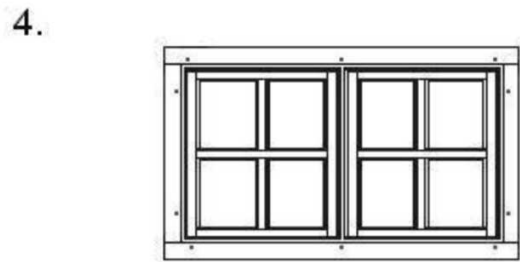

All four support trims are fixed

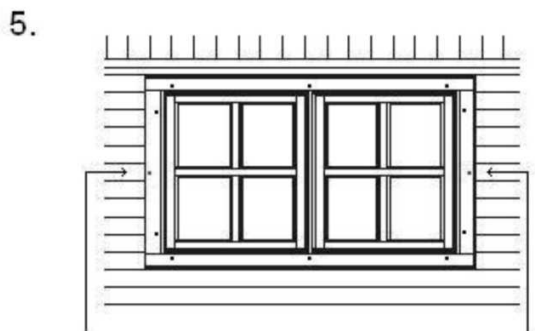

Just insert the window frame in to the space (no screwing)

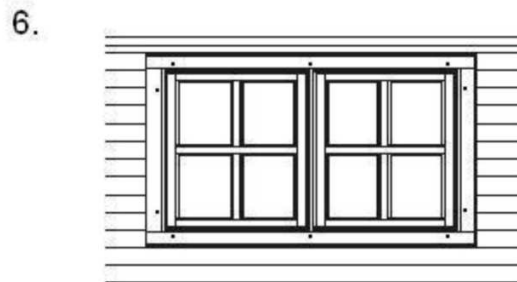

Now screw the rest four support trims in to the window frame from the other side.

4.11. Floor: Place the floor-boards across the bearers and screw them in at an angle. In this way you will have a screw-free clear floor. After the floor-boards are mounted, screw the floor-boards decorative trims in to the floor-boards.

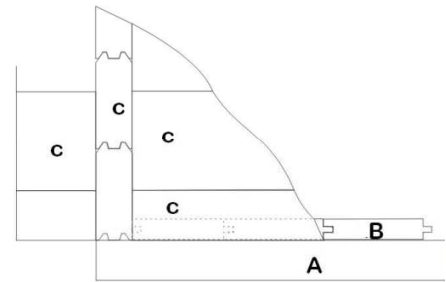
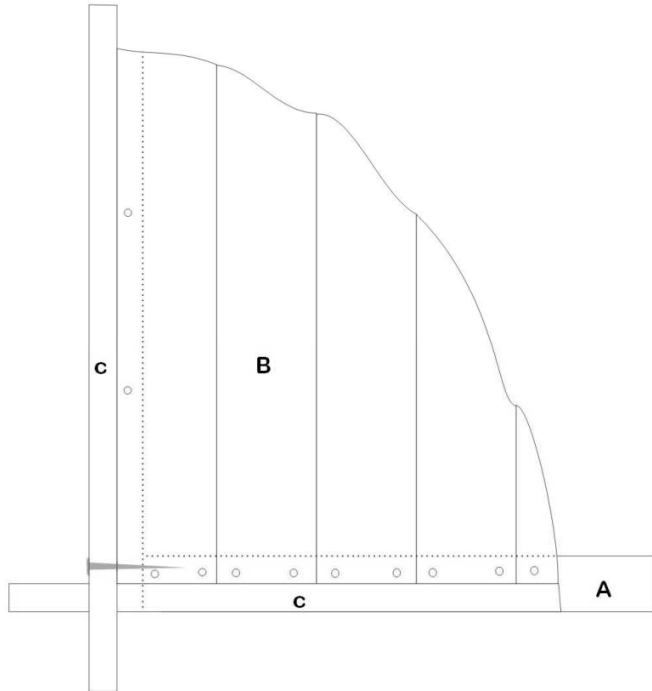

- A, - Bearers
- B, - Floor-boards
- C, - Wall-boards

4.12. Felt roof shingles: When the whole structure is assembled and has been treated, attach the felt roof shingles to the roof-boards as shown in the picture. We recommend that you cover the roof only after the structure has been treated.

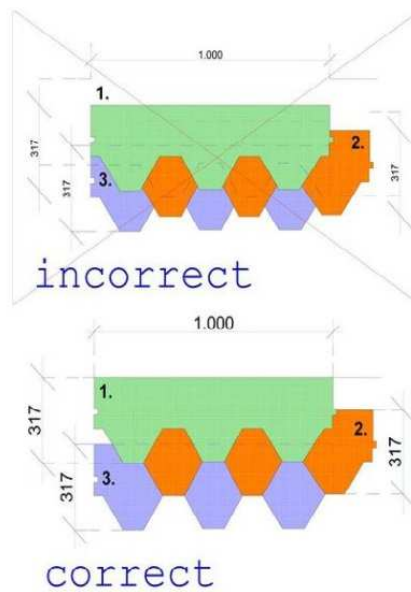

Treatment. It is important to treat the product using a quality wood-preservative instantly after the assembly process is finished. Apply at least 2 coats to the outside and 1 to the inside. Repeat annually.

After-sale service. Any missing parts or defects must be declared using the After Sales Service form (available in our web site www.quick-garden.co.uk or in the last page of this instruction) within 10 days of the product being received. Our After Sales Service will replace defective or missing parts. Make sure you fill in the After-sales service form correctly. After-sale service line + 44 207 097 0013 or clients@quick-garden.co.uk

See the terms and conditions of Quick-Garden at www.quick-garden.co.uk/general-conditions

Assembly notice – keep for later reference.

We hope you enjoy your purchase.

Sincerely yours

Quick-Garden team

Quick-Garden

Customer details: _____

Product model: _____

Please name or describe the missing or damaged parts.

Part number	Dimensions	Quantity	Reason for requesting a replacement part